

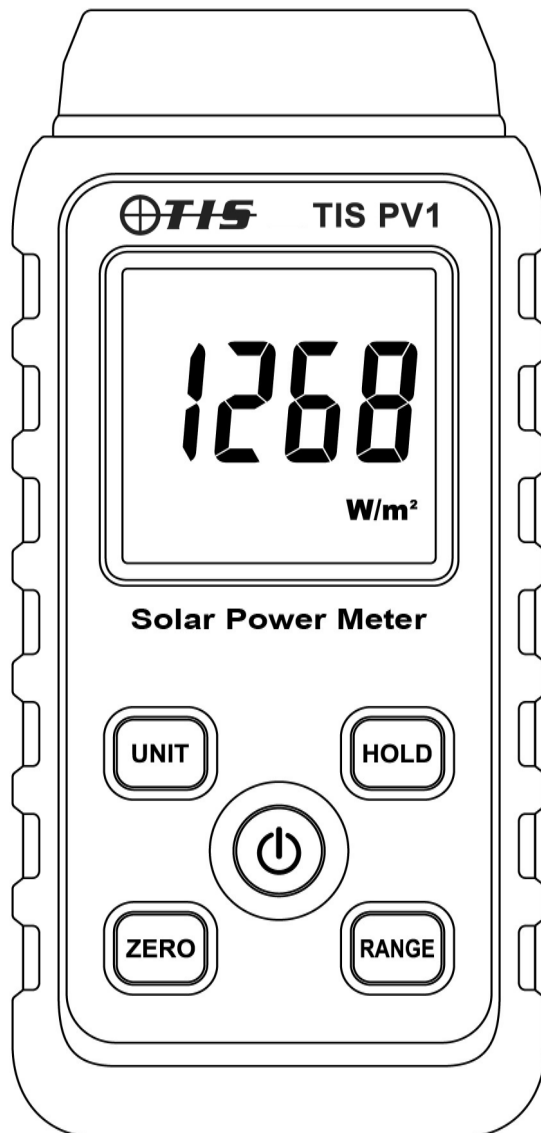







Solar Power Meter
TIS PV1
User's Manual



UK
CA

CONTENTS

1. FOREWORD.....	2
2. APPLICATIONS	2
3. FEATURES	2
4. NAME AND FUNCTION OF EACH PART.....	3
4.1. The LCD display shows:.....	3
4.2. Buttons:	3
5. Measurement Procedures.....	4
5.1. Power  button:.....	4
5.2.  BUTTON:.....	4
5.3.  BUTTON:.....	4
5.4.  Data HOLD button:	4
5.5.  button.....	4
6. TEST PROCEDURE	5
7. ELECTRIC SPECIFICATION.....	9
8. SAFETY AND MAINTENANCE	11
9. BATTERY REPLACEMENT	12
10. END OF LIFE.....	13

1. FOREWORD

Solar meter: a device used to measure solar power.

2. APPLICATIONS

- Transmission measurement is most suitable for measuring the effectiveness of the solar film.
- Solar radiation measurement.
- Car windows light intensity measurement.
- Optimal incident angle for the solar panel.
- Measurement of the sun's transmission through transparent and film glass
- Convenient, no need to adjust, data displayed clearly.

3. FEATURES

- Overload display OL.
- Select either W/m^2 or BTU / (ft²*h) units¹
Stable for long use.
- Power off: Manual on/off by push button, or auto shut off after 15 minutes

4. NAME AND FUNCTION OF EACH PART

4.1. THE LCD DISPLAY SHOWS:

	<ol style="list-style-type: none"> 1. Main display. 2. Data hold. 3. ZERO display. 4. Low battery 5. BTU (ft²*h). 6. W/m² display 7. indicator Decimal point.
--	--

4.2. BUTTONS:

	<ol style="list-style-type: none"> 1. Power button 2. ZERO button 3. UNIT button 4. Data Hold button. 5. Auto Range
--	--

5. MEASUREMENT PROCEDURES

5.1. POWER BUTTON:

- Press the “” button to turn ON or turn off.

5.2. BUTTON:

- Press the “” button for the zero adjustment if any digits is appear.

5.3. BUTTON:

- BTU (ft²*h) or W/m² unit selection.

5.4. DATA HOLD BUTTON:

Press  to enable or disable the data hold function.

5.5. BUTTON

- If display overloaded “OL”. In this case, press

the “” button, and “2000” or your acquired value then comes up.

6. TEST PROCEDURE

- Press the ZERO button for the zero adjustment if any digits is appear
- If performing the zero adjustment after powering on, several digits may not disappear. In this case, perform the zero adjustment again.
- Measure your car’s headlights:
- Turn ON your car’s headlights. Then turn ON the solar meter and “000.0” appears on the screen. Put the device down close to the headlights. Switch between high beam and low beam, and light intensity values appear on the screen. Both the right and left headlights must be tested. Note the values and put them in your car for reference. (Picture 2)
- Measure the effect of solar insulation of your vehicle’s windows:

- Press the “” button to turn ON the solar meter, “000.0” appears on the screen. Aim the device at the sun and close to a window, and the intensity appears on the screen. Open the window and aim the device at the sun. Compare the value against that acquired when the window is closed to understand the efficiency of the window’s solar film. Test your new car and preserve the measurements in it. After that, test it at least once every year. (Picture 2)

- **NOTE:** When the light sensor cover is not attached “CAP” is indicated. Make sure that it is attached. If performing the zero adjustment after powering on, several digits may not disappear. In this case, perform the zero adjustment again.

Picture 2:

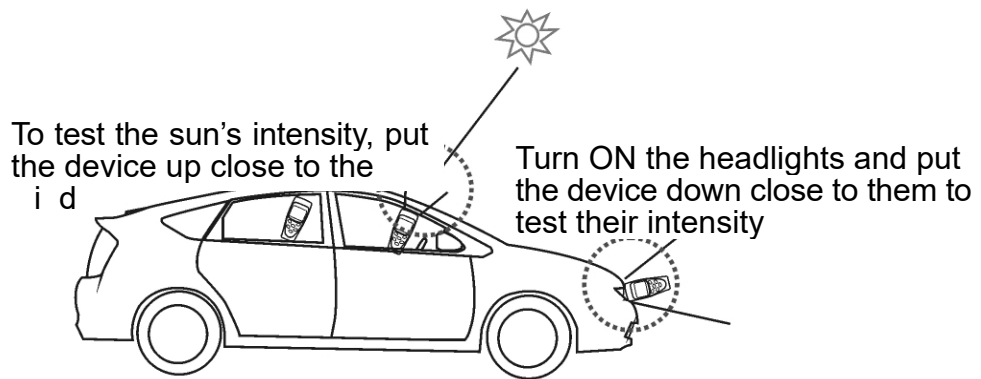

Picture 3

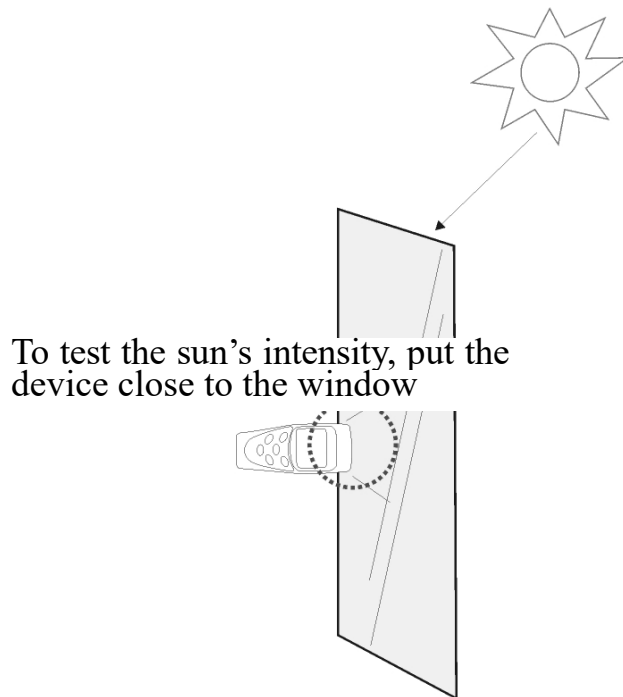

- lotion effect of your house's windows:
- Close the window. Press the “” button on your solar meter, and “000.0” comes up on the screen. Put the device close to the window and aim it at the sun. Compare the value against that acquired when the window is closed and the device is placed at the same position, in order to understand the window's heat efficiency.

(Picture 3)

7. ELECTRIC SPECIFICATION

- Battery life : approx. 50 hr.
- Accuracy: typically within $\pm 10\text{W}/\text{m}^2$ [± 3 BTU / (ft²*h)] or $\pm 5\%$, whichever is greater in sunlight; Additional temperature induced error $\pm 0.38\text{W}/\text{m}^2 / ^\circ\text{C}$ [± 0.12 BTU / (ft²*h)/ $^\circ\text{C}$] from 25 $^\circ\text{C}$
- Operating temp. & RH : 5 $^\circ\text{C}$ ~40 $^\circ\text{C}$, below 80%RH.
- Storage temp. & RH : -10 $^\circ\text{C}$ ~60 $^\circ\text{C}$, below 70%RH.
- DISPLAY: 3-3/4 digits LCD with maximum reading 3999.
- Sampling Time: Approx. 0.25 second
- Resolution: 0.1W/m²、 0.1 BTU /(ft²*h).
- Accuracy : < ± 3 /year
- Over-input: Display shows" OL".
- Range: 2000W/m² 、 634 BTU /(ft² * h).
- Dimensions & weight : 134 x 48 x 27 mm.
approx. 90g.

- EMC: this instrument is EMC-compliant and has undergone compatibility tests according to EN61326 (1997) + A1 (1998) + A2 (2001).

ACCESSORIES

- User manual.
- 2 batteries 1.5V AAA MN2400 LR03 AM4.
- Carrying case.

8. SAFETY AND MAINTENANCE

- Operating altitude: below 2,000m.
- Operating environment: for indoor use, expose to pollution level II.
- This is a precision device. During use or storage, do not go beyond its spec. to prevent any possible damage or danger.
- Do not put this device in where it is hot and/or damp.
- Remember to turn OFF the power after use. For long storage, remove the battery to prevent the battery from leaking to cause damage to the parts inside.
- Clean the device with a dry soft cloth. Wet cloths, liquid and water are prohibited.

9. BATTERY REPLACEMENT

When the symbol "  " is displayed, batteries need replacement.



CAUTION

This must be performed by technicians or trained personnel to perform.

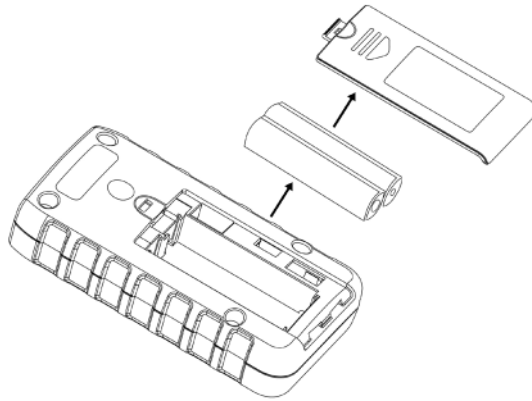

Turn OFF the meter and disconnect the test leads from the input terminals.

- Unscrew the battery cover and remove the
- battery. Insert a new battery of the same type (2 batteries 1.5V AAA MN2400 LR03 AM4)
- observing the proper polarity, re-screw the
- battery cover and reposition the protective holster.

10. END OF LIFE

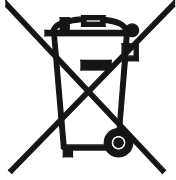

Caution: this symbol indicates that equipment and its accessories shall be subject to a separate collection and correct disposal

TEST INSTRUMENT SOLUTIONS LTD

Unit 12 / 14, Luddite Way Business Park
Rawfolds Way, Rawfolds, Cleckheaton, BD19 5DQ

Tel: 01274 752 407

www.testinstrumentsolutions.co.uk